

Radial - Werkzeughalter Form B1 rechts, kurz

B1

Radial - Toolholder Form B1 right, short

Porte - outil radial Forme B1 droite, court

Radyal kater tutucu B1 Formu sağ, kısa



Bestell-Nr. Order Nr. Référence Sipariş Nr.	Abmessung Size / Dimension Size / Cinsi	L1	h5	h6	b1	b2	b3	Kg	Euro
169.31.12	16 x 12 x 24	13	20	22	42	23	5	0,26	
209.31.16	20 x 16 x 30	16	25	30	55	30	7	0,52	
259.31.16	25 x 16 x 30	16	25	30	55	30	7	0,65	
309.31.20	30 x 20 x 40	22	28	38	70	35	10	1,24	
409.31.25	40 x 25 x 44	22	32,5	48	85	42,5	12,5	2,31	
509.31.32	50 x 32 x 55	30	35	60	100	50	16	4,31	

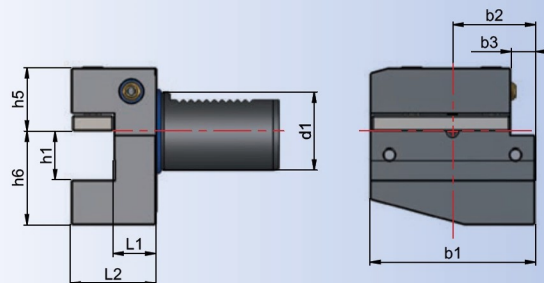

Zubehör / Accessories / Accessoires / Yedekler



Unterlegplatte
Shim
Plaque entretoise
Kater laması



Kunststoff - Kugelspritzdüse
Plastic ball sprayer nozzle
Buse d'injection spherique en plastique
Su verme misketi

Radial - Werkzeughalter Form B2 links, kurz

B2



Radial - Toolholder Form B2 left, short

Porte - outil radial Forme B2 gauche, court

Radyal kater tutucu B2 Formu sol, kısa



Bestell-Nr. Order Nr. Référence Sipariş Nr.	Abmessung Size / Dimension Size / Cinsi d1 x h1 x L2	L1	h5	h6	b1	b2	b3	Kg	Euro
169.32.12	16 x 12 x 24	13	20	22	42	23	5	0,27	
209.32.16	20 x 16 x 30	16	25	30	55	30	7	0,52	
259.32.16	25 x 16 x 30	16	25	30	55	30	7	0,65	
309.32.20	30 x 20 x 40	22	28	38	70	35	10	1,30	
409.32.25	40 x 25 x 44	22	32,5	48	85	42,5	12,5	2,32	
509.32.32	50 x 32 x 55	30	35	60	100	50	16	4,32	

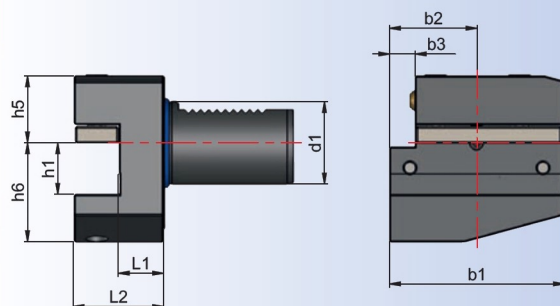

Zubehör / Accessories / Accessoires / Yedekler



Unterlegplatte
Shim
Plaque entretoise
Kater lamasi



Kunststoff - Kugelspritzdüse
Plastic ball sprayer nozzle
Buse d'injection spherique en plastique
Su verme misketi

Radial - Werkzeughalter Form B3 Überkopf rechts, kurz

B3

Radial - Toolholder Form B3 Overhead right, short

Porte - outil radial Forme B3 inversé droite, court

Radyal kater tutucu B3 Formu ters sağ, kısa

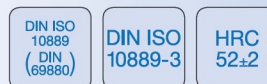

Bestell-Nr. Order Nr. Référence Sipariş Nr.	Abmessung Size / Dimension Size / Cinsi d1 x h1 x L2	L1	h5	h6	b1	b2	b3	Kg	Euro
169.33.12	16 x 12 x 24	13	22	20	42	23	5	0,26	
209.33.16	20 x 16 x 30	16	30	25	55	30	7	0,52	
259.33.16	25 x 16 x 30	16	30	25	55	30	7	0,67	
309.33.20	30 x 20 x 40	22	38	35	70	35	10	1,27	
409.33.25	40 x 25 x 44	22	48	42,5	85	42,5	12,5	2,40	
509.33.32	50 x 32 x 55	30	60	50	100	50	16	4,50	

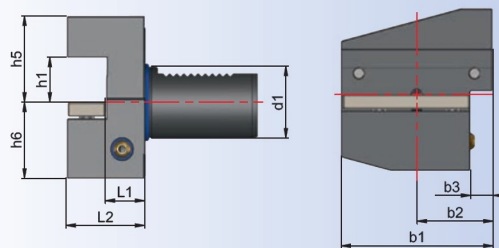

Zubehör / Accessories / Accessoires / Yedekler



Unterlegplatte
Shim



Kunststoff - Kugelspritzdüse
Plastic ball sprayer nozzle

Radial - Werkzeughalter Form B4 Überkopf links, kurz

B4

Radial - Toolholder Form B4 Overhead left, short

Porte - outil radial Forme B4 inversé gauche, court

Radyal kater tutucu B4 Formu ters sol, kısa

DIN ISO
10889
(DIN
69880)

DIN ISO
10889-3

HRC
52±2

Bestell-Nr. Order Nr. Référence Sipariş Nr.	Abmessung Size / Dimension Size / Cinsi d1 x h1 x L2	L1	h5	h6	b1	b2	b3	Kg	Euro
169.34.12	16 x 12 x 24	13	22	20	42	23	5	0,36	
209.34.16	20 x 16 x 30	16	30	35	55	30	7	0,53	
259.34.16	25 x 16 x 30	16	30	35	55	30	7	0,76	
309.34.20	30 x 20 x 40	22	38	35	70	35	10	1,29	
409.34.25	40 x 25 x 44	22	48	42,5	85	42,5	12,5	2,41	
509.34.32	50 x 32 x 55	30	60	50	100	50	16	4,60	

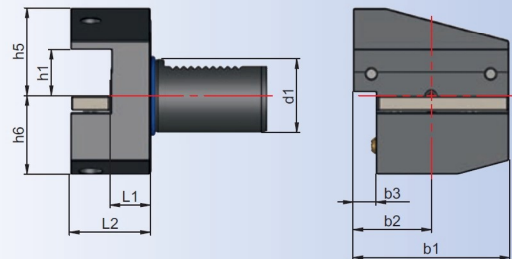

Zubehör / Accessories / Accessoires / Yedekler



Unterlegplatte
Shim
Plaque entretoise
Kater laması



Kunststoff - Kugelspritzdüse
Plastic ball sprayer nozzle
Buse d'injection spherique en plastique
Su verme misketi

Radial - Werkzeughalter Form B5 rechts, lang

B5

Radial - Toolholder Form B5 right, long

Porte - outil radial Forme B5 droite, long

Radyal kater tutucu B5 Formu sağ, uzun

DIN ISO
10889
(DIN
69880)

DIN ISO
10889-3

HRC
52±2

Bestell-Nr. Order Nr. Référence Sipariş Nr.	Abmessung Size / Dimension Size / Cinsi d1 x h1 x L2	L1	h5	h6	b1	b2	b3	Kg	Euro
169.35.12	16 x 12 x 24	13	20	22	58	39	5	0,34	
209.35.16	20 x 16 x 30	16	25	30	75	50	7	0,72	
259.35.16	25 x 16 x 30	16	25	30	75	50	7	0,87	
309.35.20	30 x 20 x 40	22	28	38	100	65	10	1,70	
409.35.25	40 x 25 x 44	22	32,5	48	118	75,5	12,5	3,00	
509.35.32	50 x 32 x 55	30	35	60	130	80	16	5,03	

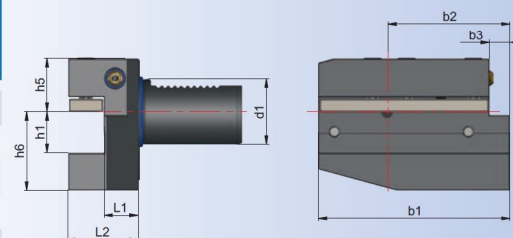

Zubehör / Accessories / Accessoires / Yedekler



Unterlegplatte
Shim
Plaque entretoise
Kater laması



Kunststoff - Kugelspritzdüse
Plastic ball sprayer nozzle
Buse d'injection spherique en plastique
Su verme misketi

Radial - Werkzeughalter Form B6 links, lang

B6



Radial - Toolholder Form B6 left, long

Porte - outil radial Forme B6 inversé gauche, long

Radyal kater tutucu B6 Formu sol, uzun

DIN ISO
10889
(DIN
69880)

DIN ISO
10889-3

HRC
52±2

Bestell-Nr. Order Nr. Référence Sipariş Nr.	Abmessung Size / Dimension Size / Cinsi d1 x h1 x L2	L1	h5	h6	b1	b2	b3	Kg	Euro
169.36.12	16 x 12 x 24	13	20	22	58	39	5	0,34	
209.36.16	20 x 16 x 30	16	25	30	75	50	7	0,72	
259.36.16	25 x 16 x 30	16	25	30	75	50	7	0,87	
309.36.20	30 x 20 x 40	22	28	38	100	65	10	1,62	
409.36.25	40 x 25 x 44	22	32,5	48	118	75,5	12,5	3,07	
509.36.32	50 x 32 x 55	30	35	60	130	80	16	5,02	

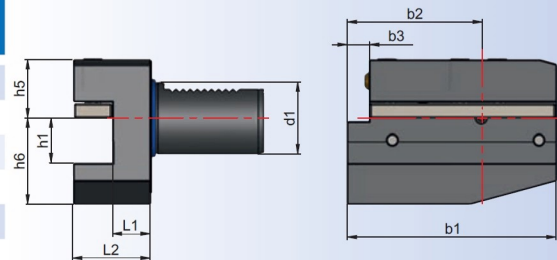

Zubehör / Accessories / Accessoires / Yedekler



Unterlegplatte
Shim
Plaque entretoise
Kater laması



Kunststoff - Kugelspritzdüse
Plastic ball sprayer nozzle
Buse d'injection spherique en plastique
Su verme misketi

Radial - Werkzeughalter Form B7 Überkopf rechts, lang

B7

Radial - Toolholder Form B7 Overhead right, long

Porte - outil radial Forme B7 inversé droite, long

Radyal kater tutucu B7 Formu kafaüstü sağ, uzun

DIN ISO
10889
(DIN
69880)

DIN ISO
10889-3

HRC
52±2

Bestell-Nr. Order Nr. Référence Sipariş Nr.	Abmessung Size / Dimension Size / Cinsi d1 x h1 x L2	L1	h5	h6	b1	b2	b3	Kg	Euro
169.37.12	16 x 12 x 24	13	22	20	58	39	5	0,34	
209.37.16	20 x 16 x 30	16	30	25	75	50	7	0,74	
259.37.16	25 x 16 x 30	16	30	25	75	50	7	0,87	
309.37.20	30 x 20 x 40	22	38	35	100	65	10	1,73	
409.37.25	40 x 25 x 44	22	48	42,5	118	75,5	12,5	3,25	
509.37.32	50 x 32 x 55	30	60	50	130	80	16	5,44	

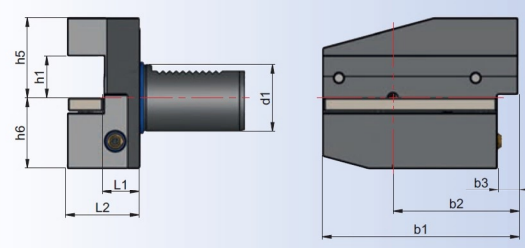

Zubehör / Accessories / Accessoires / Yedekler



Unterlegplatte
Shim



Kunststoff - Kugelspritzdüse
Plastic ball sprayer nozzle

Radial - Werkzeughalter Form B8 Überkopf links, lang

B8

Radial - Toolholder Form B8 Overhead left, long

Porte - outil radial Forme B8 inversé gauche, long

Radyal kater tutucu B8 Formu kafaüstü sol, uzun

DIN ISO
10889
(DIN
69880)

DIN ISO
10889-3

HRC
52±2

Bestell-Nr. Order Nr. Référence Sipariş Nr.	Abmessung Size / Dimension Size / Cinsi	L1	h5	h6	b1	b2	b3	Kg	Euro
169.38.12	16 x 12 x 24	13	22	20	58	39	5	0,34	
209.38.16	20 x 16 x 30	16	30	25	75	50	7	0,74	
259.38.16	25 x 16 x 30	16	30	25	75	50	7	0,88	
309.38.20	30 x 20 x 40	22	38	35	100	65	10	1,76	
409.38.25	40 x 25 x 44	22	48	42,5	118	75,5	12,5	3,27	
509.38.32	50 x 32 x 55	30	60	50	130	80	16	5,54	

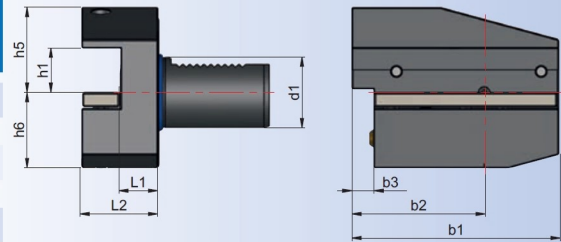

Zubehör / Accessories / Accessoires / Yedekler



Unterlegplatte
Shim
Plaque entretoise
Kater lamasi

10.44



Kunststoff - Kugelspritzdüse
Plastic ball sprayer nozzle
Buse d'injection spherique en plastique
Su verme misketi

10.50